

GH100-915R Foam Concrete Squeeze Hose Pump

GH100-915R foam concrete squeeze hose pump is a kind of peristaltic pump. An elastomeric tube is squeezed along a length by rollers that push the fluid contained within. The tube's restitution after squeezing produces a vacuum that draws fluid continuously into the tube. This creates a gentle pumping action that doesn't cause any damage to the product. Contaminations are avoided because the fluid is contained within the tube. The pump employs a rotor with rollers mounted on it that continually compress and occlude some portion of the tube. This action moves the fluid through the tube with a constant rate of displacement for each revolution of the rotor, enabling a precise measurement of the volume of fluid pumped through the tube.

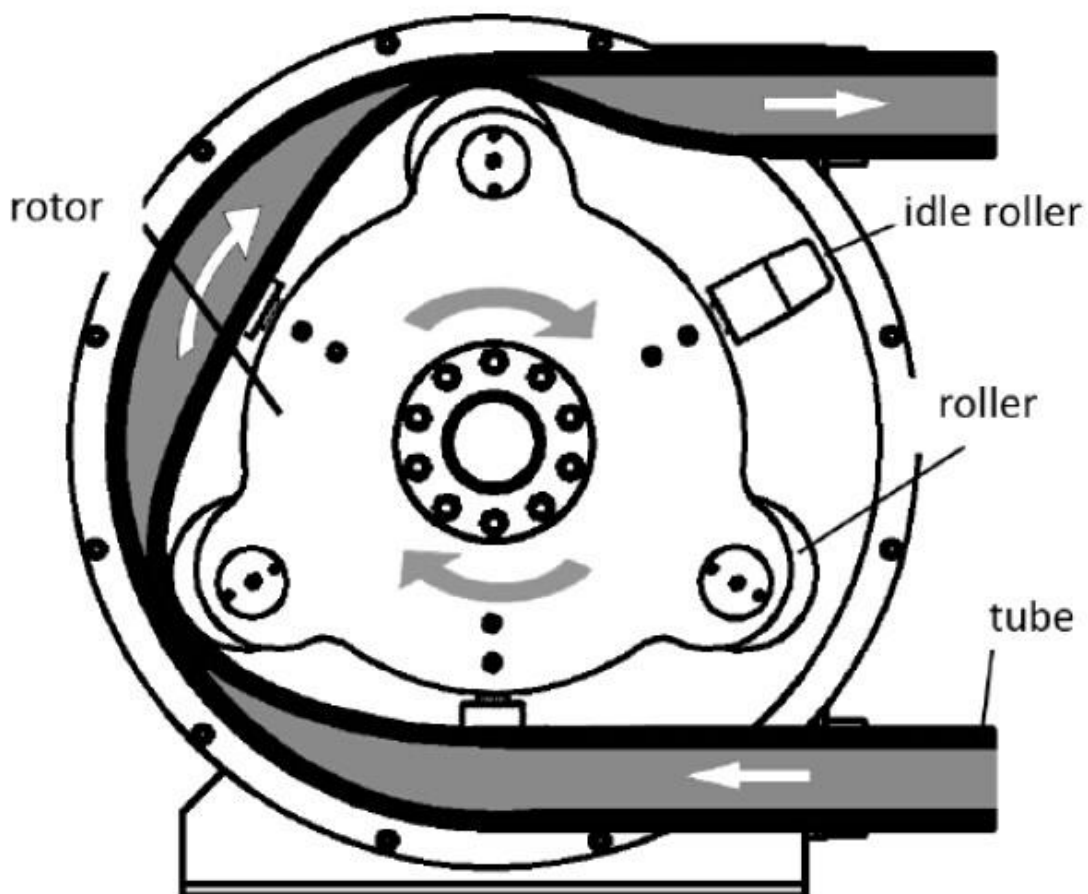

Pump Features:

- Reversibility
- Seallessness and valveless
- Abrasion resistance
- Self priming with high suction
- With 1% repeat precision
- Corrosion-resistant
- Easy to clean
- Can run dry without damage
- Peristaltic tube is the only consumption part

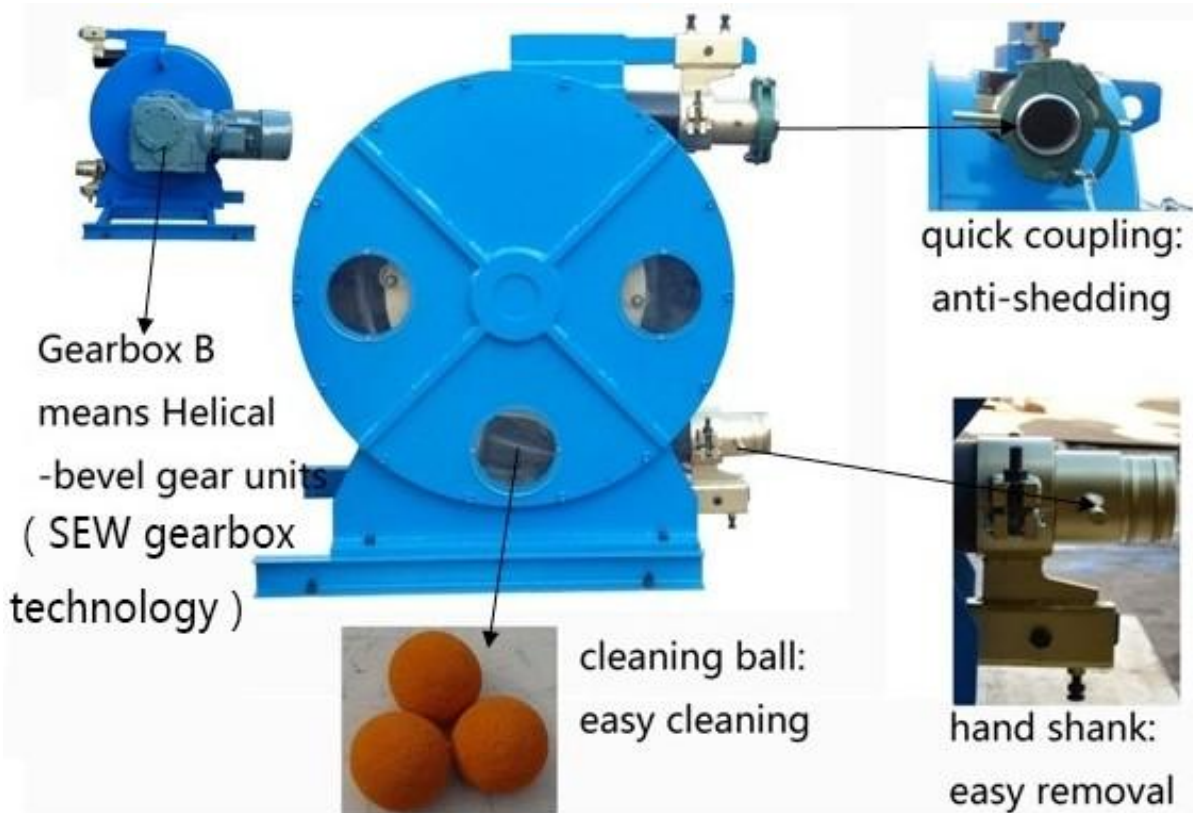

Applications:

- Water treatment: Sampling, Muds transfer, Abrasive products dosing: Lime slurry, Carbon slurry, Potassium Permanganate, etc... Chemicals dosing: Ferric Chloride, Sodium Hypochlorite, Sodium Bisulphite, Polymers, etc...
- Chemical industry: Dosing of all kinds of liquids in process, Dyes, Pigments, Paints, Detergents, Cosmetic creams, Gel, Resins, Latex, Corrosive acids, Inks, Anti-foaming, Glue, Oils, Peroxide, etc...
- Food and Beverage: Additives dosing in bakery, Beverages, Juices, Sauces, Enzymes, Syrup, Milk, Oils, Enology additives, Liquid egg, Jams, Marmalades, Meat products, Mayonnaise, etc...
- Other: Laboratory, Paper industry, Printing and packaging, Mortars, Ceramics, Agriculture, Mining, Pharmaceutical industry, Engineering, etc...

GH Hose Pump Fixing:

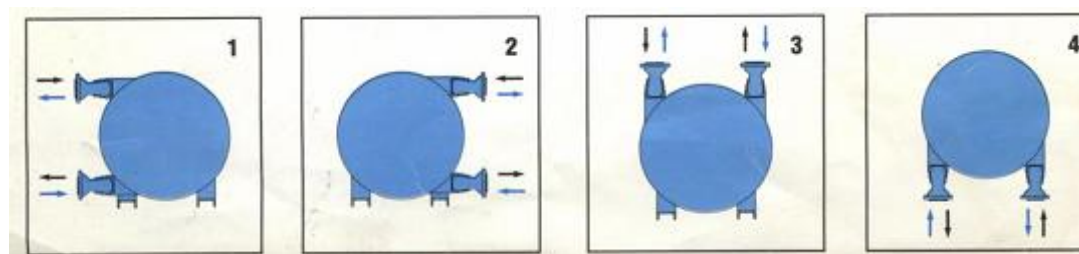



The pictures show the available fixing direction

GH100-915R Foam Concrete Squeeze Pump Specification:

Max. output	30-40m ³ /h
Rotation	45 RPM
Squeeze hose ID	102mm
Working pressure	10 Bar
Voltage	3 phase, 380V, 50HZ / 3 phase, 220V, 60HZ
Power	18.5 KW

Pictures



1) The comparison of pump core

Common pump core	GH100-915R pump core
	

2) There are three types squeeze hose for option

Chinese squeeze hose	Trelleborg squeeze hose	Enviroflex squeeze hose
		

3) The difference of Gearbox B and Gearbox C

Gearbox A means cycloidal decelerator gearbox	Gearbox B means Helical - bevel gear units (SEW gearbox technology)	Gearbox C means Chain-sprocket gearbox
		

4) GH100-915R Peristaltic hose pump in different angles



Accessories parts:



Gaode Equipment Co., Ltd.

Add: No.1307, R&D Building #5, Block B, National University Science and Technology Park of Henan Province, No.11 Changchun Road, High-Tech District, Zhengzhou City, China

Web: www.hosepumpforsale.com

Email: sales5@gaodetec.com