

## GH100-915B China Foam Concrete Pump

GH100-915B China Foam Concrete Pump is a kind of peristaltic pump. An elastomeric tube is squeezed along a length by rollers that push the fluid contained within. The tube's restitution after squeezing produces a vacuum that draws fluid continuously into the tube. This creates a gentle pumping action that doesn't cause any damage to the product. Contaminations are avoided because the fluid is contained within the tube. The pump employs a rotor with rollers mounted on it that continually compress and occlude some portion of the tube. This action moves the fluid through the tube with a constant rate of displacement for each revolution of the rotor, enabling a precise measurement of the volume of fluid pumped through the tube.

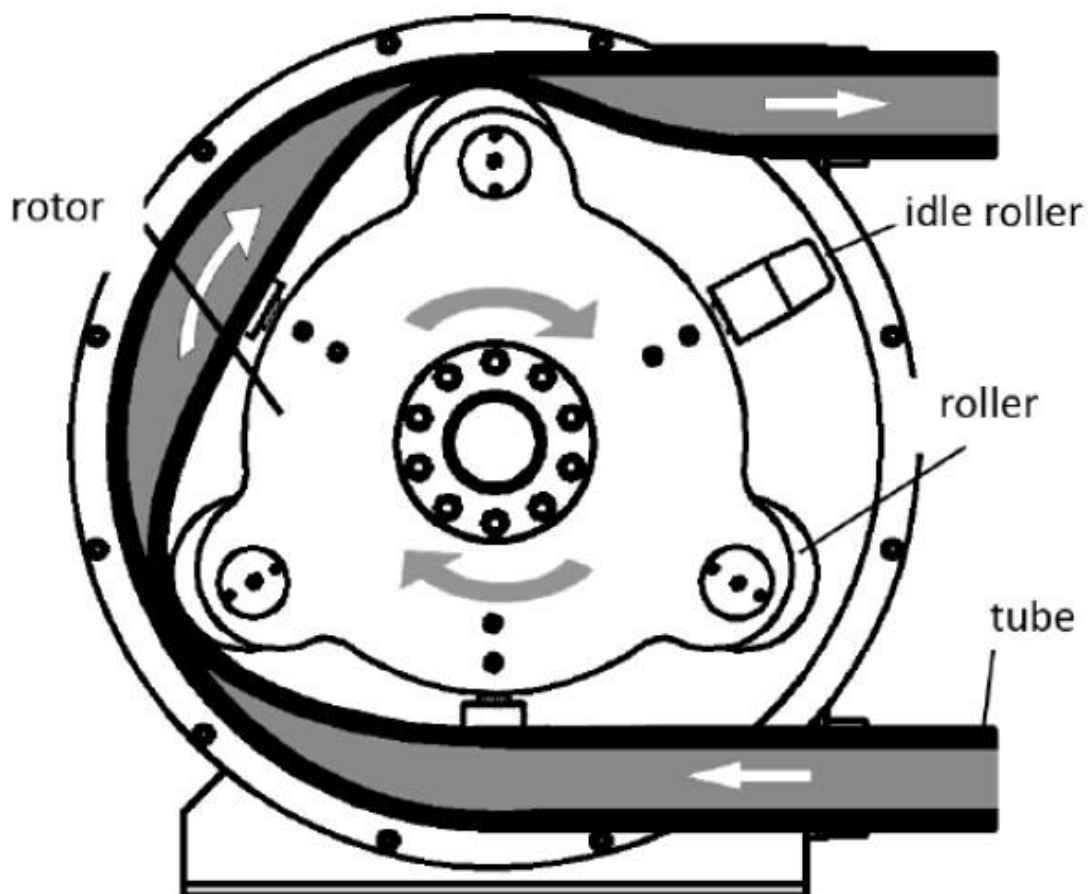

## Pump Features:

- Reversibility
- Seallessness and valveless
- Abrasion resistance
- Self priming with high suction
- With 1% repeat precision
- Corrosion-resistant
- Easy to clean
- Can run dry without damage
- Peristaltic tube is the only consumption part

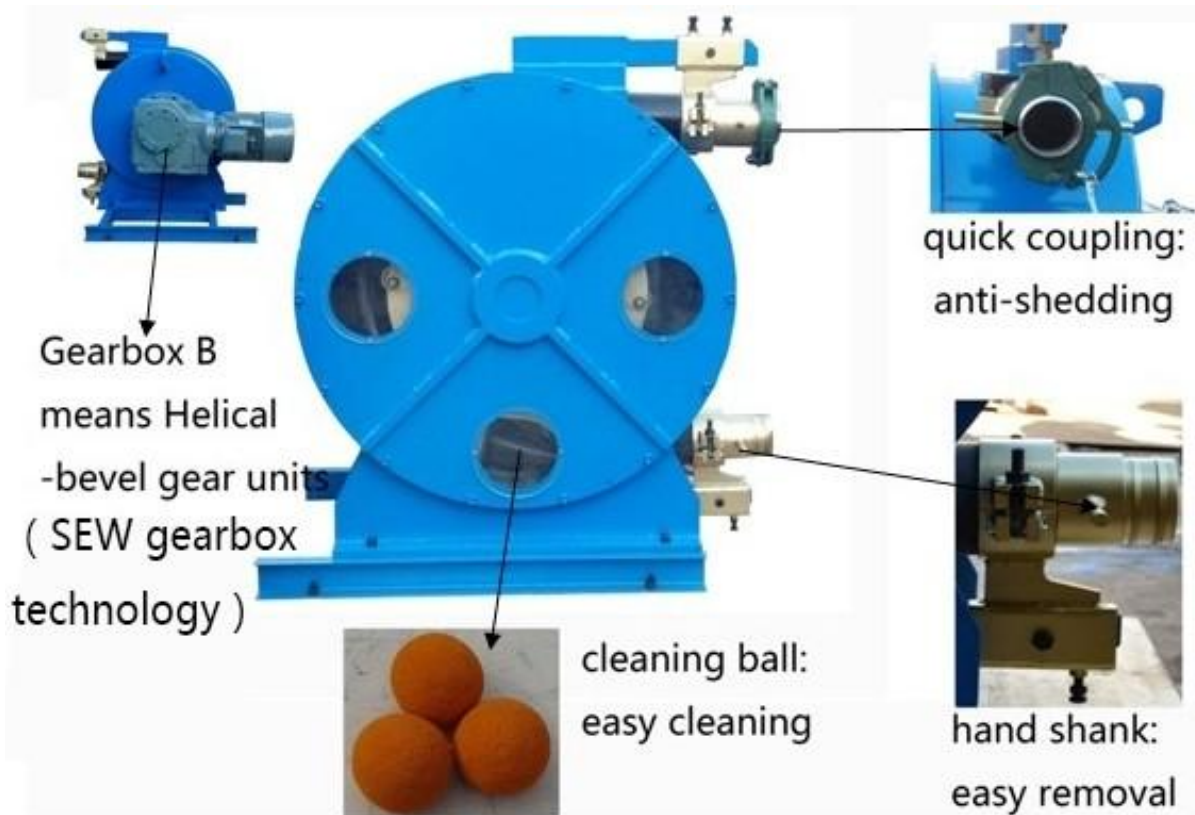

## Applications:

- Water treatment: Sampling, Muds transfer, Abrasive products dosing: Lime slurry, Carbon slurry, Potassium Permanganate, etc... Chemicals dosing: Ferric Chloride, Sodium Hypochlorite, Sodium Bisulphite, Polymers, etc...
- Chemical industry: Dosing of all kinds of liquids in process, Dyes, Pigments, Paints, Detergents, Cosmetic creams, Gel, Resins, Latex, Corrosive acids, Inks, Anti-foaming, Glue, Oils, Peroxide, etc...
- Food and Beverage: Additives dosing in bakery, Beverages, Juices, Sauces, Enzymes, Syrup, Milk, Oils, Enology additives, Liquid egg, Jams, Marmalades, Meat products, Mayonnaise, etc...
- Other: Laboratory, Paper industry, Printing and packaging, Mortars, Ceramics, Agriculture, Mining, Pharmaceutical industry, Engineering, etc...

## GH Hose Pump Fixing:

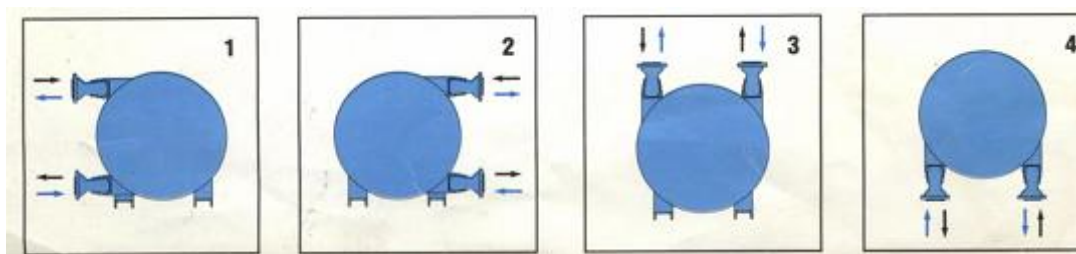



The pictures show the available fixing direction

## GH100-915B China Foam Concrete Pump Specification:

Max. output	30-40m <sup>3</sup> /h
Rotation	45 RPM
Squeeze hose ID	102mm
Working pressure	10 Bar
Voltage	3 phase, 380V, 50HZ / 3 phase, 220V, 60HZ
Power	18.5 KW

**Pictures**



**1) The comparison of pump core**

Common pump core	GH100-915B pump core
	

**2) There are three types squeeze hose for option**

Chinese squeeze hose	Trelleborg squeeze hose	Enviroflex squeeze hose
		

**3) The difference of Gearbox B and Gearbox C**

<b>Gearbox A</b> means cycloidal decelerator gearbox	<b>Gearbox B</b> means Helical - bevel gear units ( SEW gearbox technology)	<b>Gearbox C</b> means Chain-sprocket gearbox
		

**4) GH100-915B China Foam Concrete Pump in different angles**



**Accessories parts:**



**Gaode Equipment Co., Ltd.**

Add: No.1307, R&D Building #5, Block B, National University Science and Technology Park of Henan Province, No.11 Changchun Road, High-Tech District, Zhengzhou City, China

Web: [www.hosepumpforsale.com](http://www.hosepumpforsale.com)

Email: sales5@gaodetec.com