

GH100-915B Industrial Squeeze Peristaltic Pump

GH100-915B Industrial Squeeze Peristaltic Pump is a kind of peristaltic pump. An elastomeric tube is squeezed along a length by rollers that push the fluid contained within. The tube's restitution after squeezing produces a vacuum that draws fluid continuously into the tube. This creates a gentle pumping action that doesn't cause any damage to the product. Contaminations are avoided because the fluid is contained within the tube. The pump employs a rotor with rollers mounted on it that continually compress and occlude some portion of the tube. This action moves the fluid through the tube with a constant rate of displacement for each revolution of the rotor, enabling a precise measurement of the volume of fluid pumped through the tube.

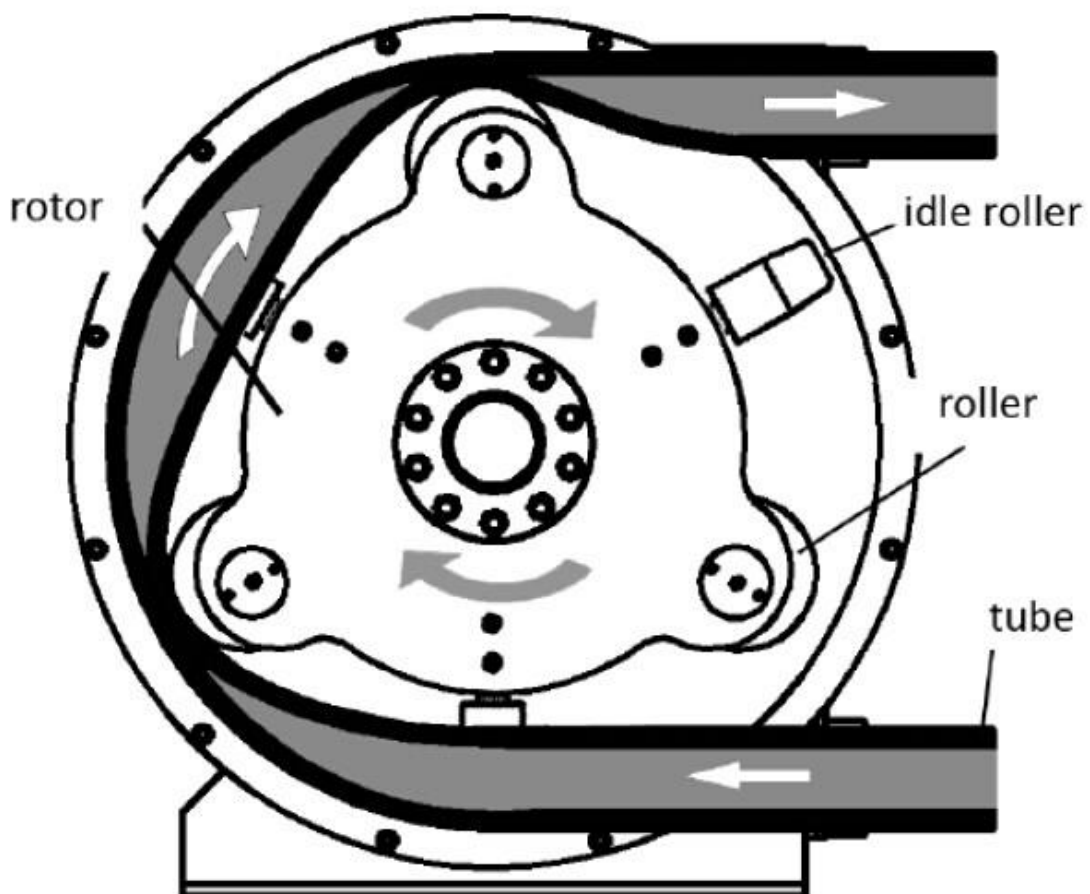

Pump Features:

- Reversibility
- Seallessness and valveless
- Abrasion resistance
- Self priming with high suction
- With 1% repeat precision
- Corrosion-resistant
- Easy to clean
- Can run dry without damage
- Peristaltic tube is the only consumption part



Applications:

- Water treatment: Sampling, Muds transfer, Abrasive products dosing: Lime slurry, Carbon slurry, Potassium Permanganate, etc... Chemicals dosing: Ferric Chloride, Sodium Hypochlorite, Sodium Bisulphite, Polymers, etc...
- Chemical industry: Dosing of all kinds of liquids in process, Dyes, Pigments, Paints, Detergents, Cosmetic creams, Gel, Resins, Latex, Corrosive acids, Inks, Anti-foaming, Glue, Oils, Peroxide, etc...
- Food and Beverage: Additives dosing in bakery, Beverages, Juices, Sauces, Enzymes, Syrup, Milk, Oils, Enology additives, Liquid egg, Jams, Marmalades, Meat products, Mayonnaise, etc...
- Other: Laboratory, Paper industry, Printing and packaging, Mortars, Ceramics, Agriculture, Mining, Pharmaceutical industry, Engineering, etc...

GH Hose Pump Fixing:

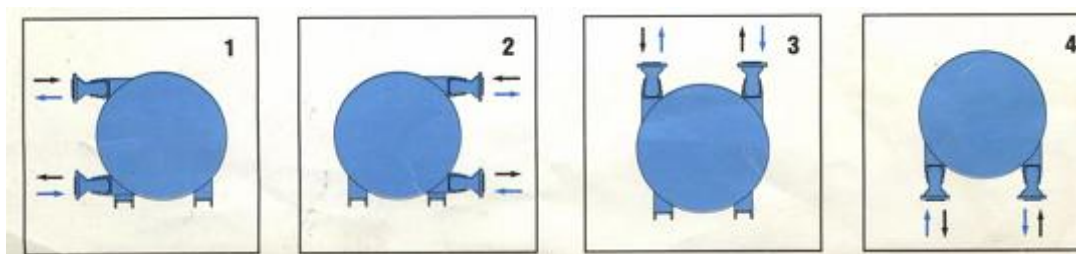



The pictures show the available fixing direction

GH100-915B Industrial Squeeze Peristaltic Pump Specification:

| | |
|------------------|---|
| Max. output | 30-40m ³ /h |
| Rotation | 45 RPM |
| Squeeze hose ID | 102mm |
| Working pressure | 10 Bar |
| Voltage | 3 phase, 380V, 50HZ / 3 phase, 220V, 60HZ |
| Power | 18.5 KW |

Pictures



1) The comparison of pump core

| Common pump core | GH100-915B core |
|---|--|
|  |  |

2) There are three types squeeze hose for option

| Chinese squeeze hose | Trelleborg squeeze hose | Enviroflex squeeze hose |
|---|---|--|
|  |  |  |

3) The difference of Gearbox B and Gearbox C

| Gearbox A means cycloidal decelerator gearbox | Gearbox B means Helical - bevel gear units (SEW gearbox technology) | Gearbox C means Chain-sprocket gearbox |
|---|---|--|
|  |  |  |

4) GH100-915B Industrial Squeeze Peristaltic Pump in different angles



Accessories parts:



Gaode Equipment Co., Ltd.

Add: No.1307, R&D Building #5, Block B, National University Science and Technology Park of Henan Province, No.11 Changchun Road, High-Tech District, Zhengzhou City, China

Web: www.hosepumpforsale.com

Email: sales5@gaodetec.com